

NOTES:

IMPORTANT - PLEASE READ AND KEEP IN MIND THE FOLLOWING: IF, FOR ANY REASON, YOU ARE NOT SURE WHICH CLIP-ON BRACKET IS REQUIRED PLEASE CONTACT ZIGGITY.

1.) CLIP-ON BRACKETS WITH PT. NRS. 1120 & 1122 FIT:

- ZIGGITY MANUFACTURED BIG ACE PIPE UNITS WITH EITHER TWIN LOCK (T/L) OR SINGLE LOCK (S/L) SADDLES

- BIG ACE SIZED PIPE (33.33 MM O.D.) WITH GLUE-ON T/L SADDLES (PT. NR. 1829) OR GLUE-ON S.L SADDLES (PT. NR. 1924)

2.) PT. NR. 1120 & PT. NR. 1122 CLIP-ON BRACKETS DO NOT FIT ON:

- ZIGGITY MANUFACTURED BIG Z PIPE UNITS WITH BIG Z SADDLES
 - ANY PIPE WITH GLUE-ON BIG Z SADDLES (PT. NR. 1835)
 - ANY AND ALL PIPE INSTALLED WITH CLIP-ON SADDLES W/GROMMETS (PT. NRS. 2385, 2386, 2387 AND 2388)

3.) SELECT EITHER PT. NR. 1120 AND PT. NR. 1122 BASED ON THE OUTSIDE DIAMETER (O.D.) OF THE SUPPORT PIPE:

- PT. NR. 1120 FITS SUPPORT PIPE WITH AN O.D. OF 26.67MM(+/-0.13MM) OR 1.050 INCHES(+/-0.005)

- PT. NR. 1122 FITS SUPPORT PIPE WITH AN O.D. OF 27.10MM(+/-0.20MM) OR 1.067 INCHES(+/-0.007)

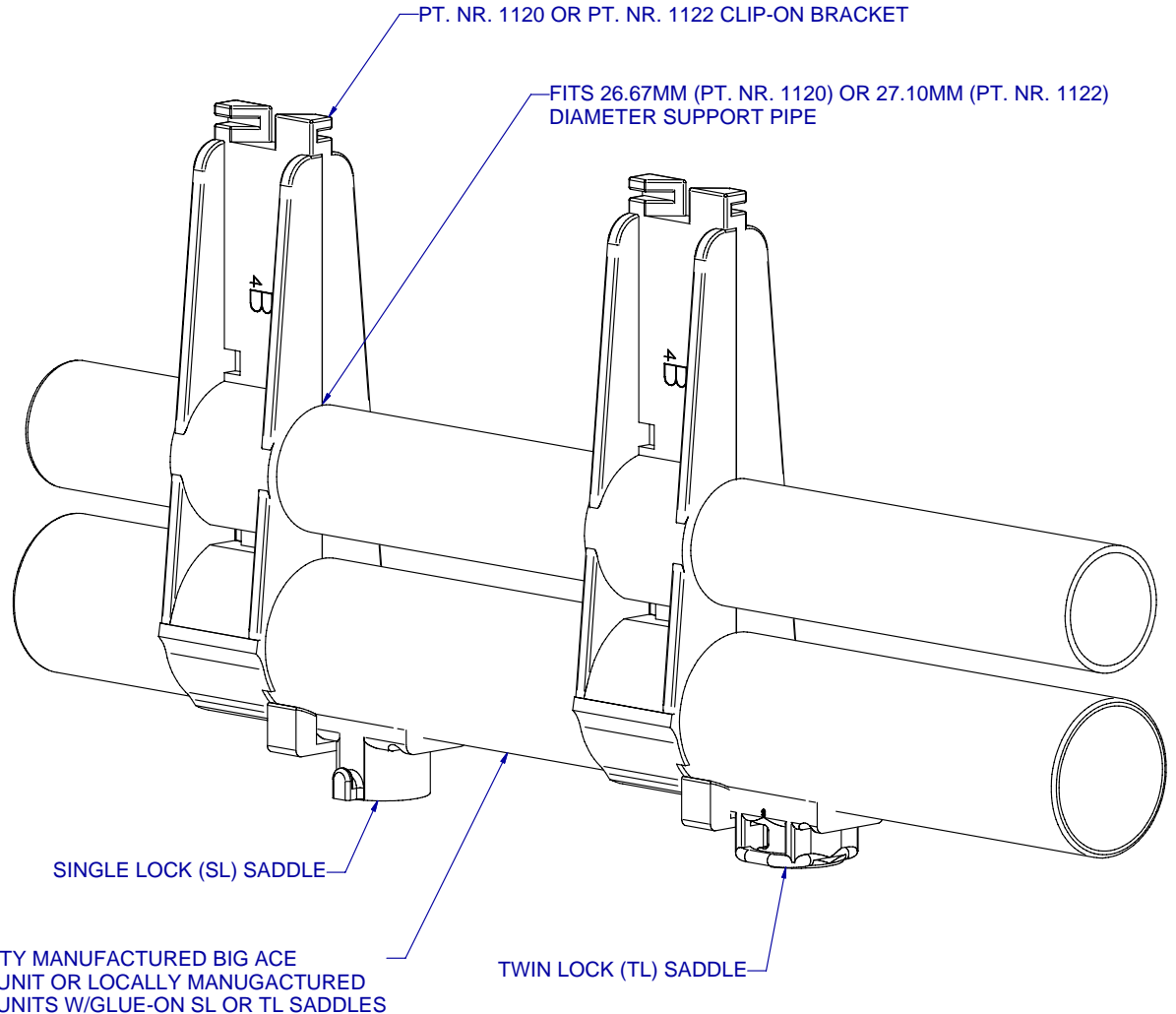

COMPATIBILITY: CLIP-ON BRACKETS TO TL AND SL SADDLES

PART NR.:

DATE: 8-3-01

REVISION: 5

GL1008