

SCALE: 10%

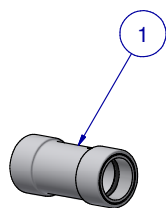

SCALE 1 / 4

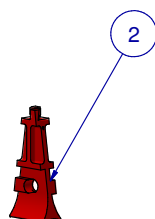

SCALE 1 / 4

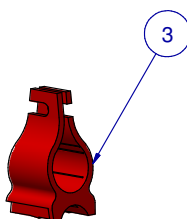

SCALE 1 / 4

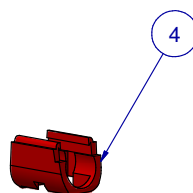

SCALE 1 / 4

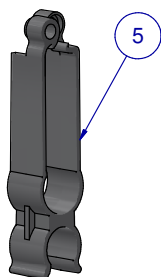

SCALE 1 / 4

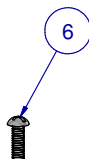

SCALE 1 / 4

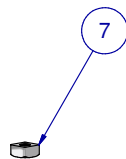

SCALE 1 / 4

ITEM	PART NR.	QTY	DESCRIPTION	BIN
1	260	1	PIPE CONNECTOR: ACE - WHITE	E
2	2136	4	BRACKET: AKTIVE - TOP	C
3	2137	4	BRACKET: AKTIVE - MIDDLE	C
4	2138	4	BRACKET: AKTIVE - BOTTOM	C
5	2118	1	HANGER: SUPPORT PIPE - ACE	C
6	159	4	FASTENER: SCREW PAN HD PHILLIPS 1/4" - 20 X 3/4" LG	H
7	160	4	FASTENER: NUT CROWN SQ 1/4" - 20 X 7/16" WD X 1/4" H	H
8	20430508	1	PIPE UNIT: ACE SL 3 M W/37.5 CM SPACING 8 SADDLES	B

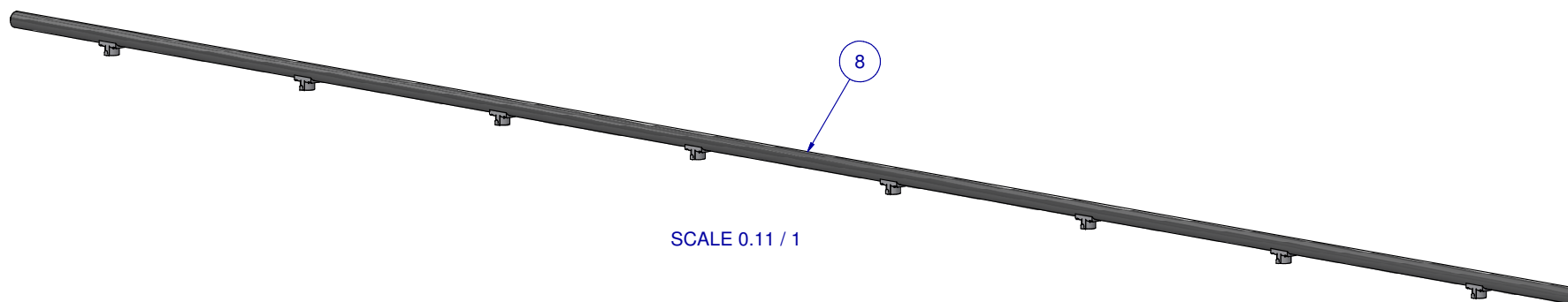

SCALE 0.11 / 1



KIT: FLOOR ACE AKTIVE SL 3 M W/37.5 CM SPACING 8 SADDLES

PART NR.:

DATE: 10-31-12

REVISION:

10030508